

SINGLE-SUPPLY DUAL HIGH CURRENT OPERATIONAL AMPLIFIER

■ GENERAL DESCRIPTION

The NJM3414A integrated circuit is a high gain, high output current, high output voltage swing dual operational amplifier capable of driving 70mA.

■ FEATURES

- Single Supply
- Operating Voltage (+3V ~ +15V)
- High Output Current (70mA)
- Slew Rate (1.0V/μs typ.)
- Package Outline DIP8, DMP8, SIP8, SSOP8
- Bipolar Technology

■ PACKAGE OUTLINE

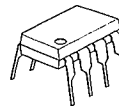

NJM3414AD



NJM3414AM

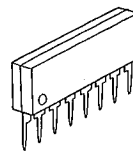

NJM3414AL



NJM3414AV

※S-Type (SID-9) available

■ PIN CONFIGURATION

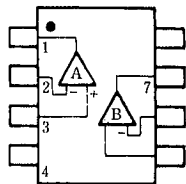

NJM3414AD  
NJM3414AM  
NJM3414AV

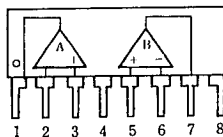

NJM3414AL

PIN FUNCTION

1. A OUTPUT
2. A-INPUT
3. A+INPUT
4. GND
5. B+INPUT
6. B-INPUT
7. B OUTPUT
8. V<sup>-</sup>

■ EQUIVALENT CIRCUIT (1/2 Shown)

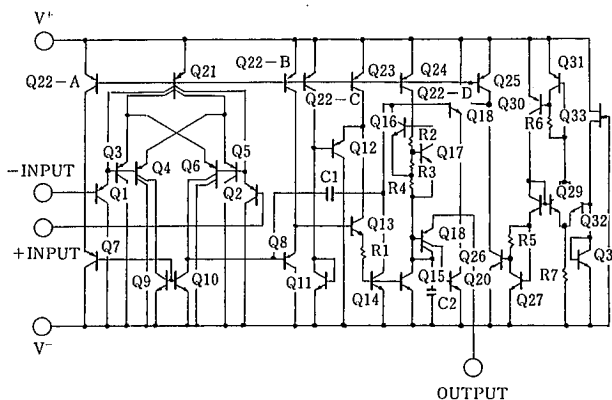

■ ABSOLUTE MAXIMUM RATINGS

(Ta=25°C)

PARAMETER	SYMBOL	RATINGS	UNIT
Supply Voltage	V*(V*/V-)	15V(or ±7.5)	V
Differential Input Voltage	V <sub>ID</sub>	15	V
Input Voltage	V <sub>IC</sub>	-0.3~+15	V
Power Dissipation	P <sub>D</sub>	(DIP8) 500	mW
		(DMP8) 300	mW
		(SSOP8) 250	mW
		(SIP8) 800	mW
Operating Temperature Range	T <sub>opr</sub>	-20~+75	°C
Storage Temperature Range	T <sub>stg</sub>	-40~+125	°C

■ ELECTRICAL CHARACTERISTICS

(Ta=25°C, V<sup>+</sup>=8.6V)

PARAMETER	SYMBOL	TEST CONDITION	MIN.	TYP.	MAX.	UNIT
Input Offset Voltage	V <sub>IO</sub>	R <sub>S</sub> =0Ω	—	2	5	mV
Input Offset Current	I <sub>IO</sub>		—	5	100	nA
Input Bias Current	I <sub>B</sub>		—	100	500	nA
Large Signal Voltage Gain	A <sub>V</sub>	R <sub>L</sub> =2kΩ	88	100	—	dB
Input Common Voltage Range	V <sub>ICM</sub>		V <sup>+</sup> -2	—	—	V
Maximum Output Voltage Swing 1	V <sub>OM1</sub>	R <sub>L</sub> ≥2kΩ, V <sup>+</sup> =5V	3.5	—	—	V
Maximum Output Voltage Swing 2	V <sub>OM2</sub>	I <sub>O</sub> =70mA, V <sup>+</sup> =5V	3.2	—	—	V
Common Mode Rejection Ratio	CMR		80	90	—	dB
Supply Voltage Rejection Ratio	SVR		80	90	—	dB
Operating Current	I <sub>CC</sub>	R <sub>L</sub> =∞	3	4	5	mA
Slew Rate	SR		—	1.0	—	V/μS
Gain Bandwidth Product	GB		—	1.3	—	MHz
Operating Voltage Range	V <sup>+</sup>		—	—	15	V

4

## TYPICAL APPLICATIONS

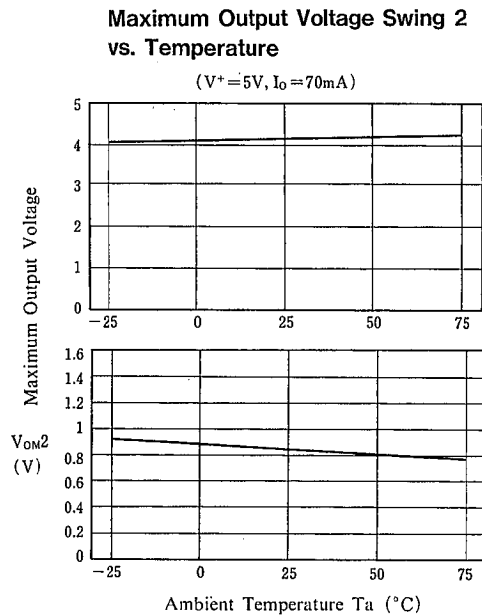
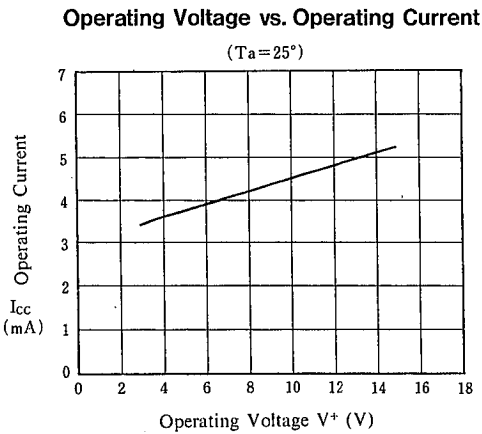
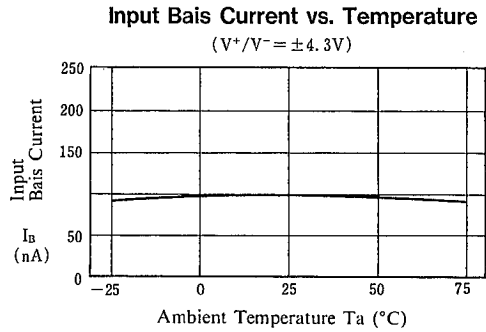
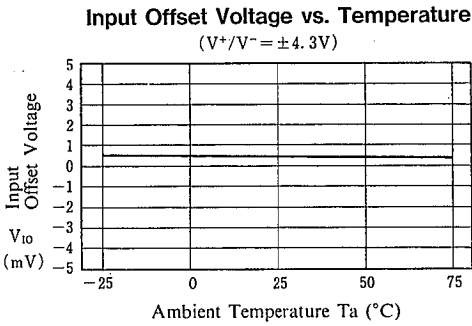
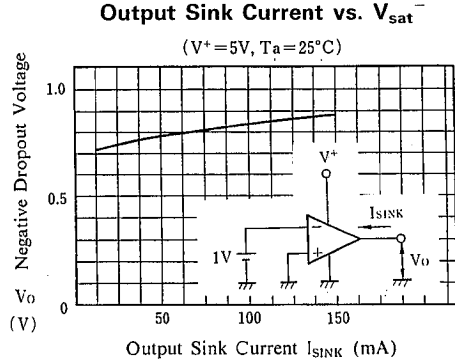
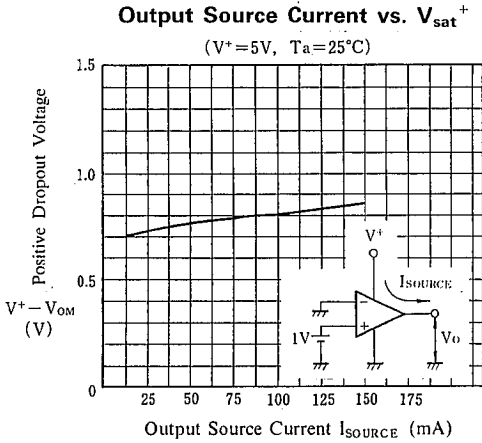

■ TYPICAL CHARACTERISTICS

Maximum Output Voltage vs. Operating Voltage

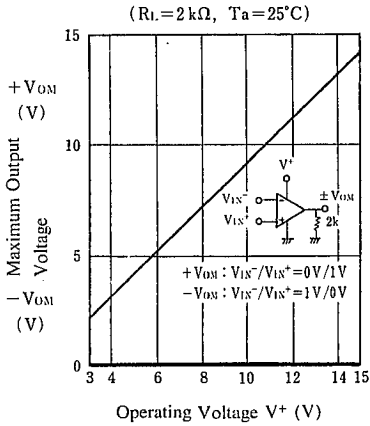

Maximum Output Voltage vs. Load Resistance

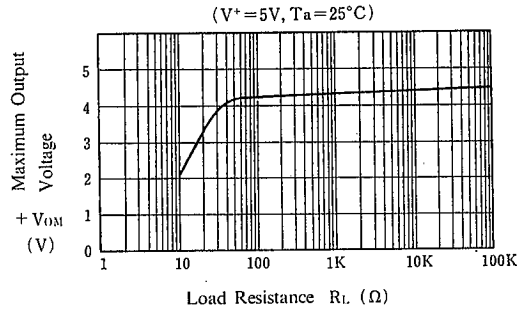

Maximum Output Voltage vs. Frequency

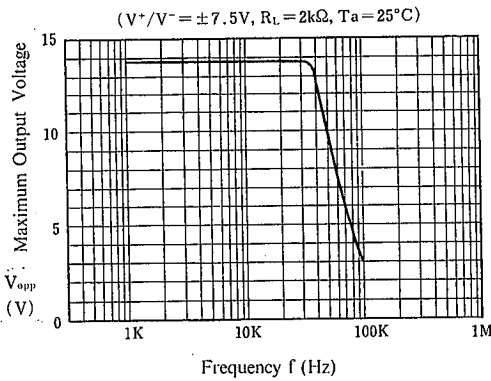

Voltage Gain, Phase vs. Frequency

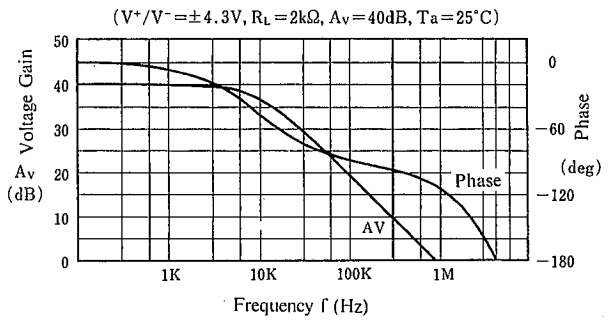

Operating Current vs. Temperature

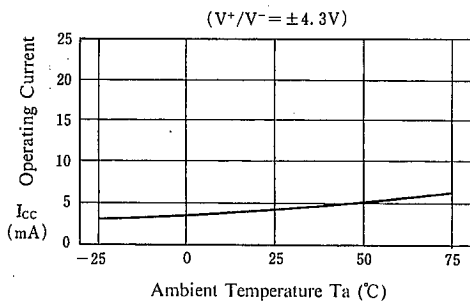

Maximum Output Voltage vs. Temperature

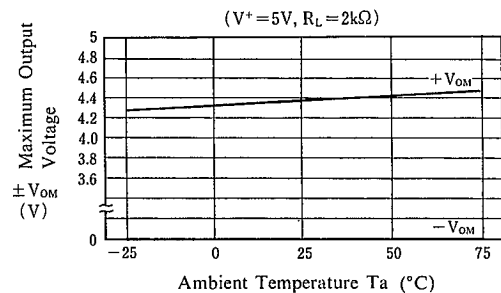

## MEMO

[CAUTION]

The specifications on this databook are only given for information, without any guarantee as regards either mistakes or omissions. The application circuits in this databook are described only to show representative usages of the product and not intended for the guarantee or permission of any right including the industrial rights.